



Blinds Catalogue



Welcome



Harmony

Established in 1985, Harmony is based in Ninghai in the region of Ningbo, Zhejiang Province, China. Harmony manufactures a wide range of window decoration products.

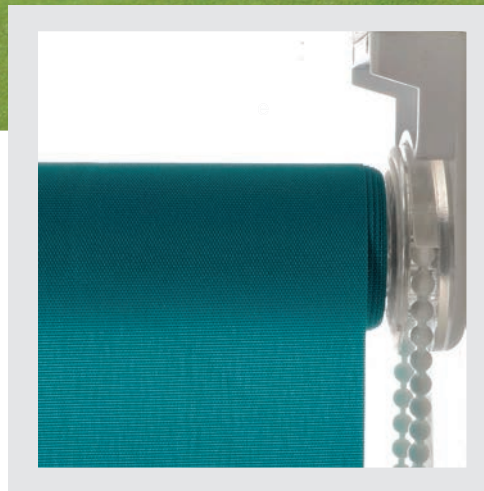

Products

The company specialises in the production of roller blinds offering a wide range of fabrics, textures, prints and sheers. Roman blinds, vertical blinds, pleated blinds, metal curtain poles and top quality accessories and components complete the range of products available.



Global

Harmony is currently supplying customers around the globe. The company has experience and a full understanding of the western way of product design and sourcing and aims to meet every need of the customer where possible.



Harmony is China's leading manufacturer of high quality window decoration products.

Offering the widest range of ready-made blinds and accessories from their production facility in Ningbo.



Service

Harmony prides itself in offering the complete service to its customers. With market wide knowledge, first class production facilities and product development. Harmony cover everything their customers need for a smooth and efficient service, direct from the manufacturer.



European Office

For better access, contact and communication, the Harmony international sales office is based in Central England, offering Europe wide representation and service. This office gives customers a more local contact point for access to the Harmony factory in China. Harmony is not an agency, Harmony is a manufacturing company.



Group of Companies

Harmony is the brand which represents the group of companies:

- Ningbo Grand Home Furnishing Co. Ltd
- Ningbo Gileko Commodity Co. Ltd
- Harmony Home Furnishings Ltd
- P&H International Ltd

Contents

Welcome

- 2-3** Introduction to Harmony
- 4** Contents
- 6** Service
- 7** Accreditations
- 8-9** Child Safety

Roller Blinds

- 10-11** Roller Blind Information
- 12-15** Roller Blind Types/Styles
- 16-17** Easy-Fix Roller Blinds
- 18-19** Day & Night Roller Blinds

Roman Blinds

- 20** Roman Blind Info
- 21** Roman Blind Styles
- 22-23** Trim to Size Roman Blinds

Vertical Blinds

- 24** Vertical Blind Information
- 25** Vertical Blind Styles

Pleated Blinds

- 26** Pleated Blind Information
- 27** Pleated Blind Images

Panel Blinds

- 28** Panel Blind Information
- 29** Panel Blind Images

Accessories

- 30-31** Roller Blind Accessories

Harmony Factory Photos

- 32-35** Factory Images

Contact us

- 36-37** Factory & Sales Contact Details
- 38-39** Notes



Service

Harmony provides the complete service for a comprehensive range of window decoration products. From the smallest to the largest customer, Harmony offer their market knowledge and product experience to provide unparalleled service and support from China and Europe.

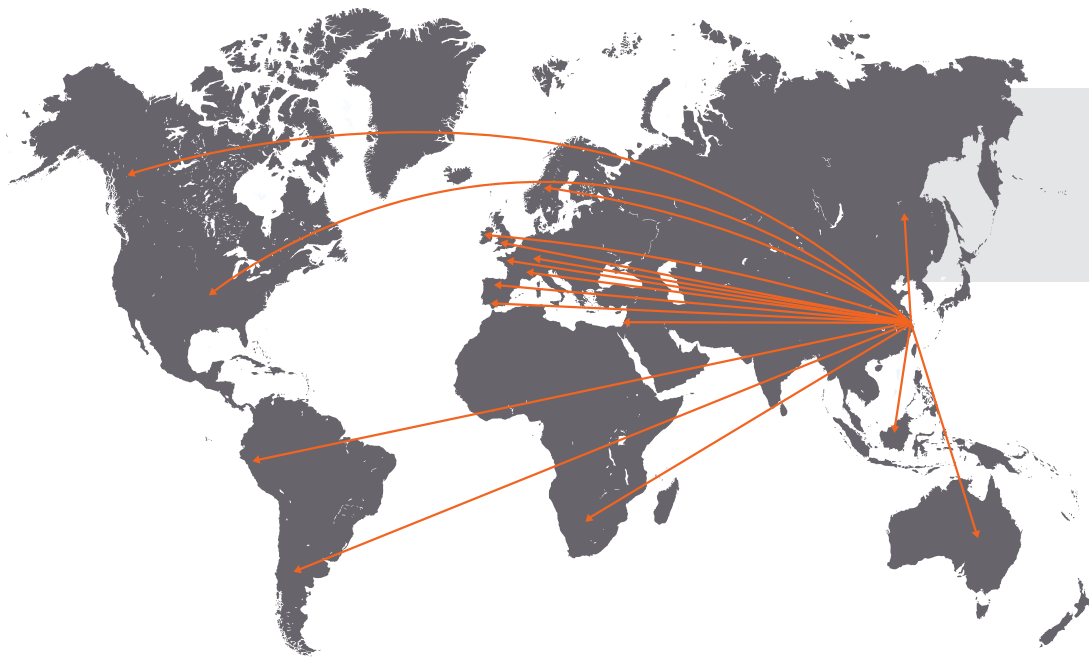
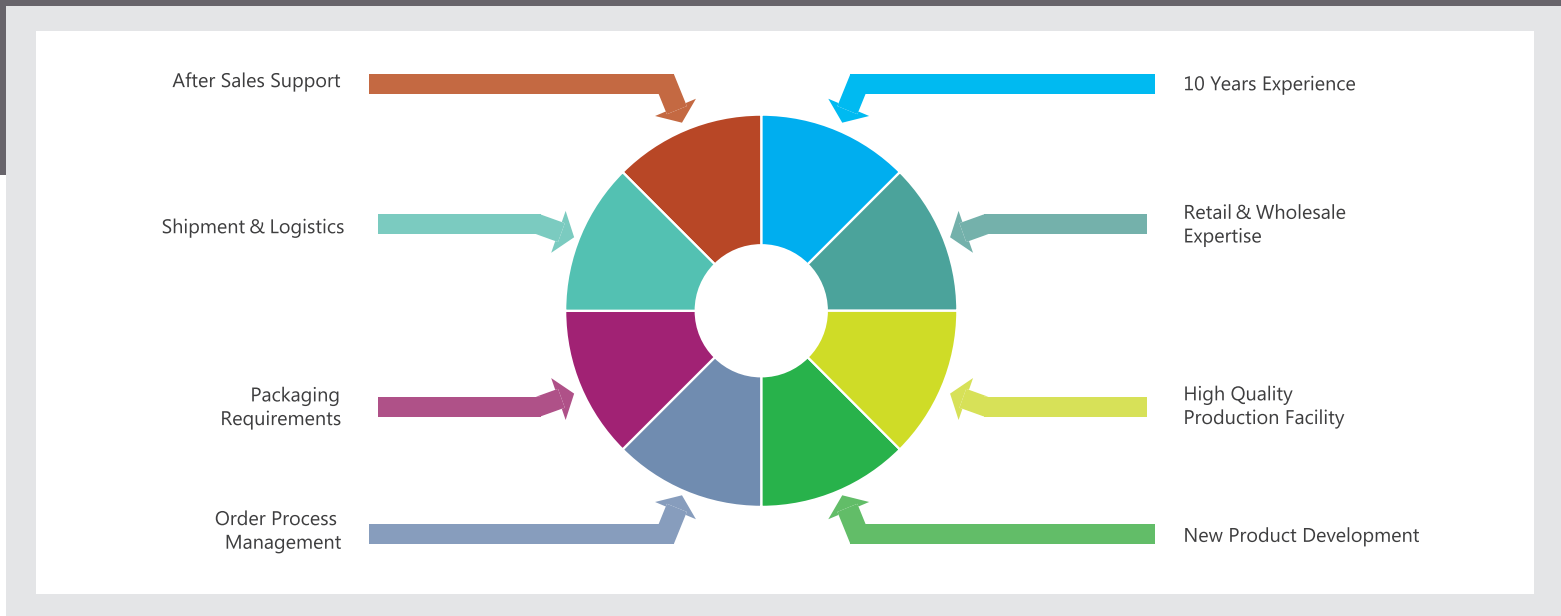

Harmony manufacture and distribute to customers around the globe.

Accreditations

Harmony is qualified to be accredited to the following agencies displaying their quality of production and service both technically and ethically. Below is a list of companies which recognise Harmony for high quality production and quality control, together with providing an ethical place of work.



Accredited

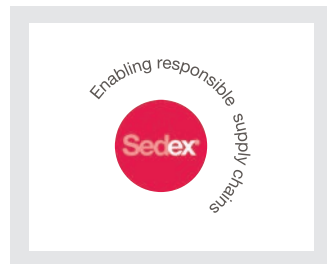

Audit & QC Partner

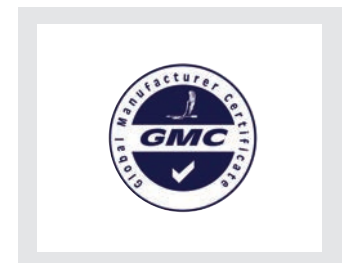
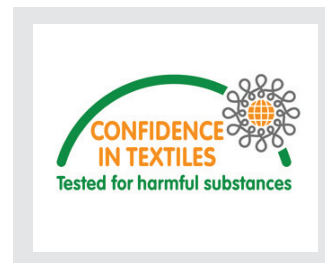

Child Safety

Window blind cords and chains can pose a risk for babies, children and vulnerable people who could injure or even strangle themselves on hazardous cords and control chains.

As a BBSA member (UK), Harmony are very active in developing simple, effective low-cost safety features that are suitable for all types of blinds. These include a safe way of securing the cords by tension devices, as well as connectors that simply pull apart should undue pressure be applied, but can be easily re-connected.

We place the highest emphasis on the safe installation of all our products to Europe and further afield. Taking additional steps to ensure all our components meet the new European standard EN13120 and with BBSA guidelines, we ensure any product we supply can be fitted with a safety device.

Typical examples of safety devices:

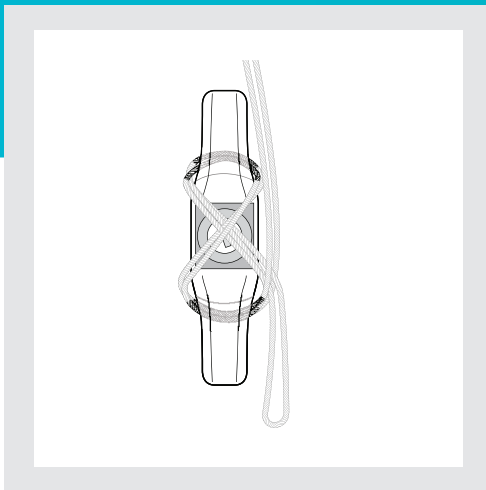

Cleat Hook

A cleat hook is typically used for tidying cords of Roman and Venetian blinds. This should be securely fixed to an adjacent wall, out of the reach of children and the cord secured as shown, after each operation of the blind.



Cord or Chain Tidy

A cord or chain tidy is typically used for tidying the cord or chain of a roller blind. This device is secured to an adjacent wall and the cord or chain is held permanently within the device.

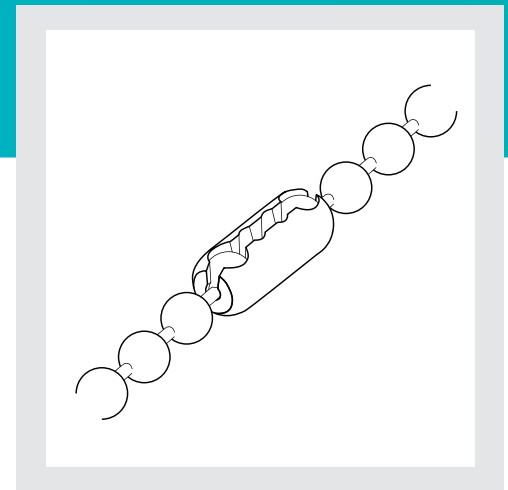

Chain break connectors

Chain connectors should be included on all control chains of all ready-made blinds. These will break apart when undue pressure is applied to the operating chain.

Harmony's standard child safety features:

- All-readymade blinds include a safety device attached to the control chain tested to EN16434
- All control chains have the European standard warning label attached with pictogram according to EN61310-1 and wording according to EN13120
- Control chains come fitted with a chain connector allowing the chain to be broken easily at less than 6Kg (standard BS7231-1:1190) according to EN16434
- All fitting instructions include European standard warning according to EN13120, including additional safety advice for a correct and safe installation of safety devices.

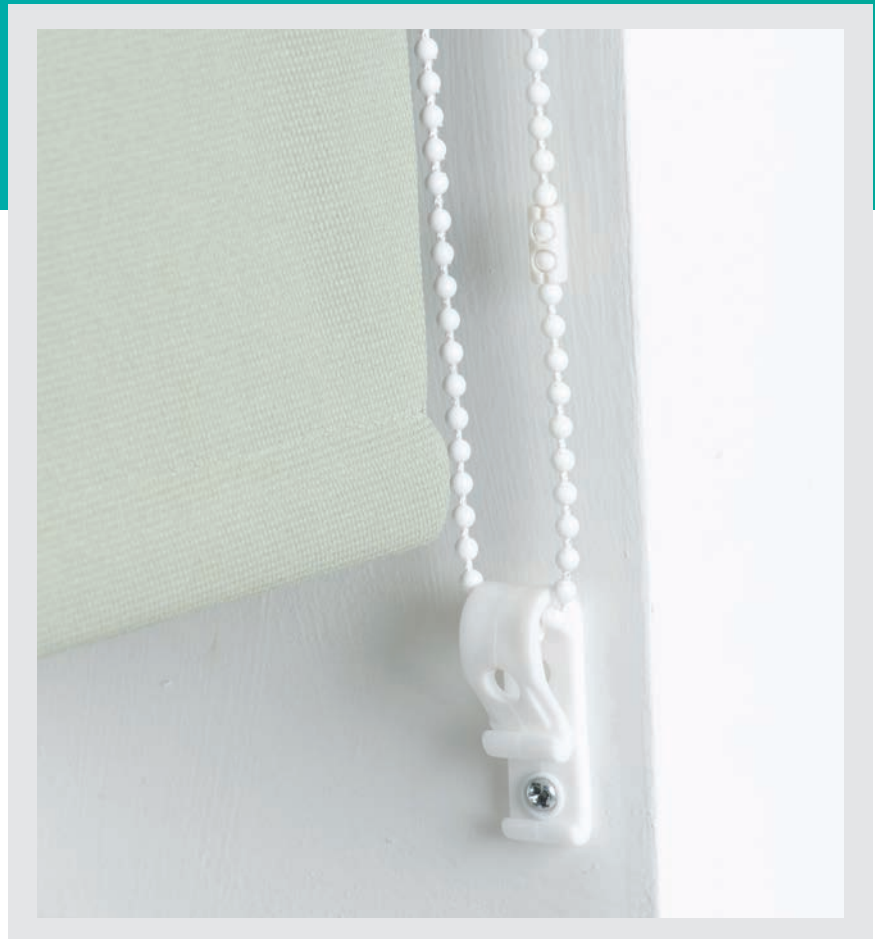

Roller Blinds

Roller blinds are a simple and effective form of window decoration. These blinds can be made in a wide range of styles, fabrics and prints to fit almost any window. Harmony carry a stock range of 48 plain colours as well as a collection of sheer, textured and structure fabrics.

Fabrics available:

100% Polyester 150 x 150 Denier
 100% Polyester 150 x 300 Denier
 100% Polyester 200 x 200 Denier
 100% Polyester 300 x 300 Denier
 Blackout Coating (Colour Matched White or Silver)
 Printed Fabrics (Screen, Transfer or Pigment)
 Flock Printed Fabrics
 Linen
 Hessian
 Chinese Wood Weave
 Structure
 Sheer

Centre Tubes:

Circular Aluminium
 Slotted Aluminium
 Steel
 Convolute

Packaging:

PET box
 PVC box
 Cardboard box
 Mail order box

Scale of sizes:

EUROPE

| | | |
|-------------|-------------|-------------|
| 60 x 160cm | 60 x 175cm | 60 x 230cm |
| 90 x 160cm | 80 x 175cm | 80 x 230cm |
| 120 x 160cm | 100 x 175cm | 100 x 230cm |
| 150 x 160cm | 110 x 175cm | 110 x 230cm |
| 180 x 160cm | 120 x 175cm | 120 x 230cm |
| 210 x 160cm | 140 x 175cm | 140 x 230cm |
| 240 x 160cm | 160 x 175cm | 160 x 230cm |
| | 180 x 175cm | 180 x 230cm |
| | 90 x 210cm | 90 x 230cm |

| | |
|-------------|-------------|
| 45 x 190cm | 32 x 170cm |
| 60 x 190cm | 37 x 170cm |
| 90 x 190cm | 42 x 170cm |
| 100 x 190cm | 52 x 170cm |
| 120 x 190cm | 62 x 170cm |
| 140 x 190cm | 67 x 170cm |
| 150 x 190cm | 87 x 170cm |
| 180 x 190cm | 107 x 170cm |

AUSTRALIA

| |
|-------------|
| 60 x 210cm |
| 90 x 210cm |
| 120 x 210cm |
| 150 x 210cm |
| 180 x 210cm |
| 210 x 210cm |

SOUTH AMERICA

| |
|-------------|
| 120 x 165cm |
| 150 x 165cm |
| 180 x 165cm |
| 90 x 220cm |
| 120 x 220cm |

Container Quantities:

| | PET BOX | MAIL ORDER |
|-------------------|-----------|------------|
| 20FT CONTAINER | 7,000pcs | 3,000pcs |
| 40FT CONTAINER | 14,000pcs | 6,000pcs |
| 40FT HC CONTAINER | 16,500pcs | 7,500pcs |

Sizes Available:

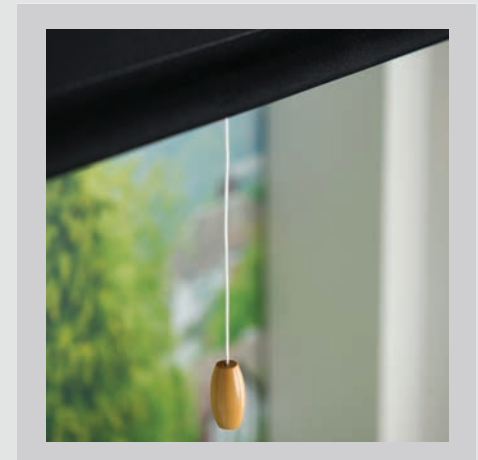
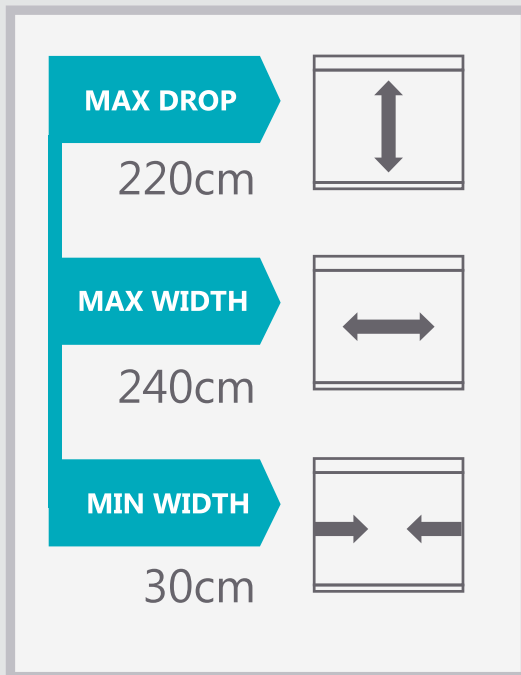

Any print design can be made upon request; screen costs and lead times may vary for custom designs. Plain daylight fabrics offer a value option whilst blackout and textured fabrics are the solution for a core or premium product.

Standard Specification

- Are made from using a fabric of your choice.
- Have a slotted 25mm aluminium centre tube.
- Have a 25mm sidewinder mechanism.
- Have a sidewinder which can be top, face or side fitted.
- Are available in your choice of colours.
- Fit all windows in all countries.
- Can be made in custom colours and sizes to your specification.
- Are packed in clear PET boxes for a clean durable presentation.
- Come complete with full colour header cards and fitting instructions.
- All components are tested and approved to the latest E13120 standards.



Roller Blind Types / Styles

Plain Daylight



Blackout



Scallop

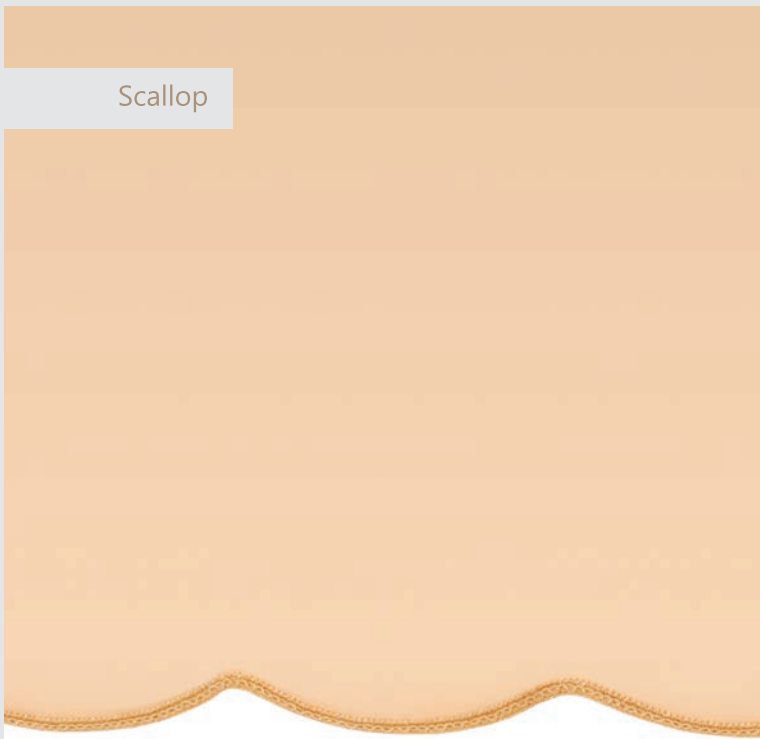

Straight Edge

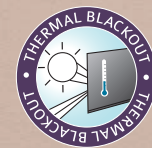

Transfer Print

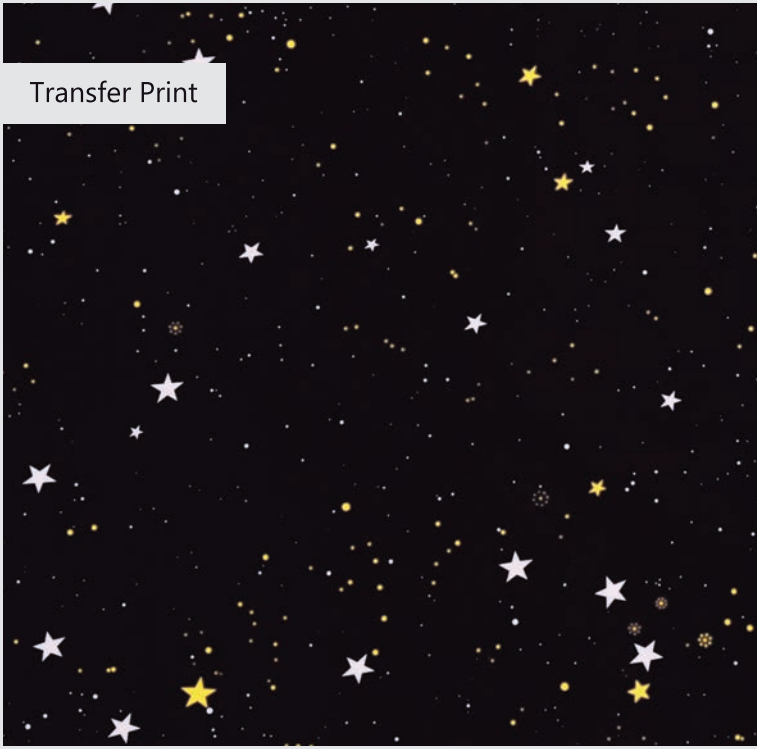

Flock Print



Screen Print



Pigment Print

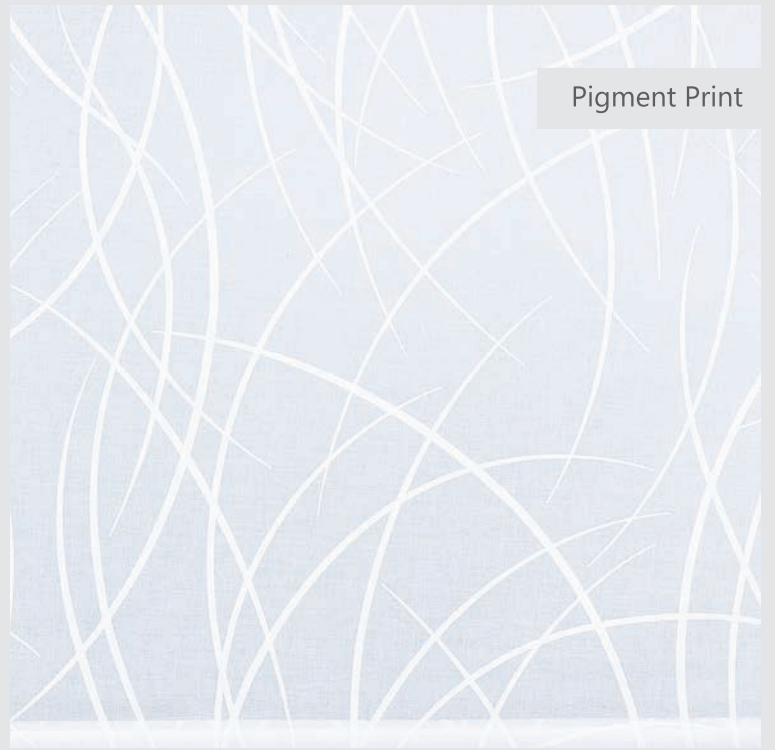

Roller Blind Types / Styles

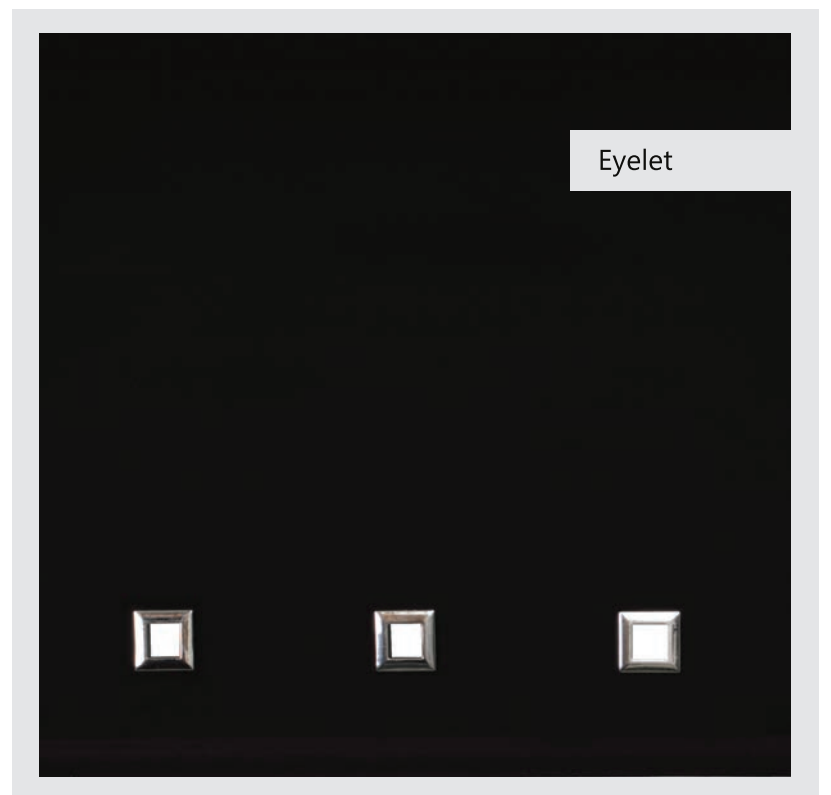

Wood Weave



Sunscreen



Structure

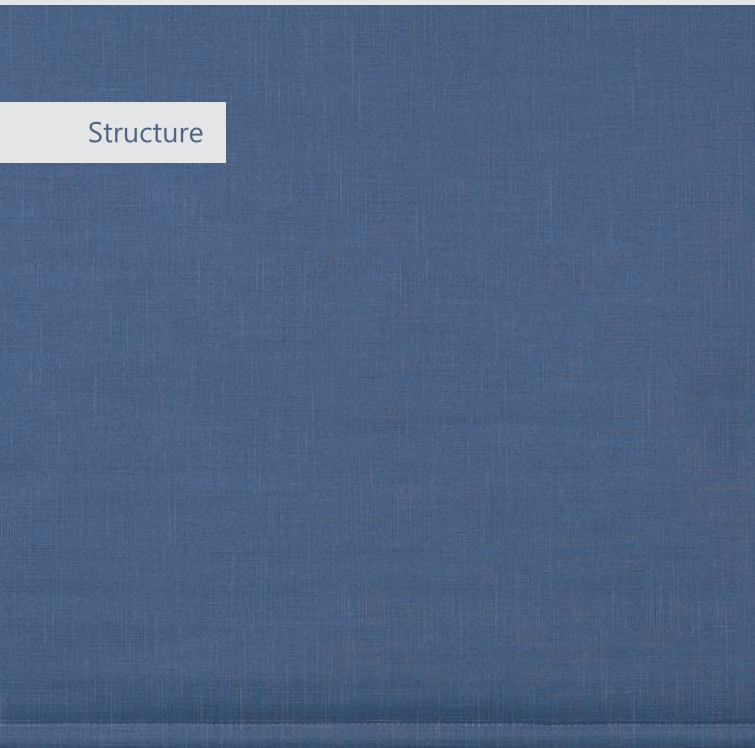

Textured



Easy-Fix Roller Blinds

- Are made using a fabric of choice.
- Have a slotted 25mm aluminium centre tube.
- Have a 25mm sidewinder mechanism.
- Have a sidewinder which can be top, face or side fitted.
- Are available in your choice of colours.
- Fit all windows in all countries.
- Can be made in custom colours and sizes to your specification.
- Are packed in clear PET boxes for a clean durable presentation.
- Come complete with full colour header cards and fitting instructions.

Fabrics Available

100% Polyester 150 x 150 Denier
 100% Polyester 150 x 300 Denier
 100% Polyester 200 x 200 Denier
 100% Polyester 300 x 300 Denier
 Blackout Coating (Colour Matched White or Silver)
 Printed Fabrics (Screen, Transfer or Pigment)
 Flock Printed Fabrics
 Linen
 Hessian
 Chinese Wood Weave
 Structure
 Sheer

Centre Tubes:

Circular Aluminium Steel
 Slotted Aluminium Convolute

Container Quantities:

| | PET BOX | MAIL ORDER |
|-------------------|-----------|------------|
| 20FT CONTAINER | 7,000pcs | 3,000pcs |
| 40FT CONTAINER | 14,000pcs | 6,000pcs |
| 40FT HC CONTAINER | 16,500pcs | 7,500pcs |

Packaging:

PVC box Cardboard box
 PET box Mail order box

Sizes Available:

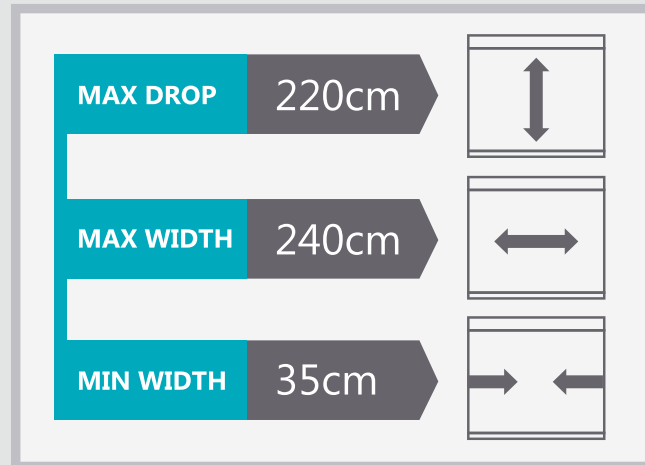

Scale of sizes:

| | | |
|-------------|-------------|-------------|
| 45 x 150cm | 45 x 200cm | 120 x 150cm |
| 55 x 150cm | 55 x 200cm | 130 x 150cm |
| 60 x 150cm | 60 x 200cm | 140 x 150cm |
| 70 x 150cm | 70 x 200cm | 150 x 150cm |
| 75 x 150cm | 75 x 200cm | |
| 80 x 150cm | 80 x 200cm | |
| 90 x 150cm | 90 x 200cm | |
| 110 x 150cm | 110 x 200cm | |

3 Fitting Options

Clip to window frame

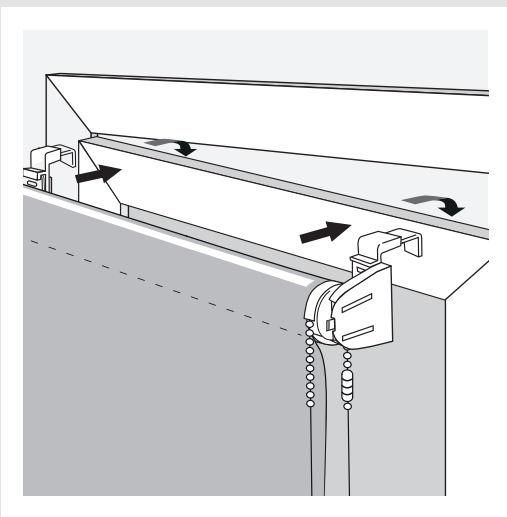

Screw to window surround

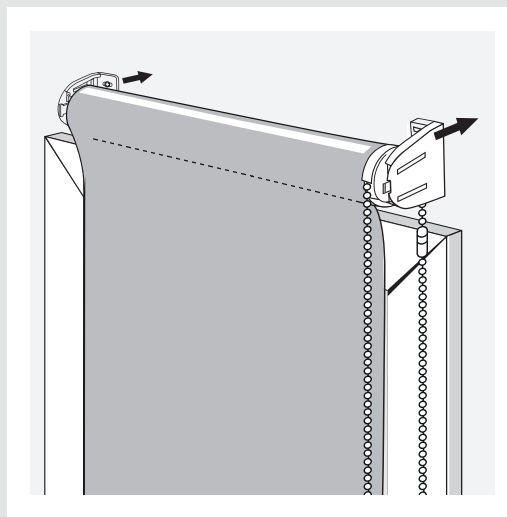

Stick to window frame

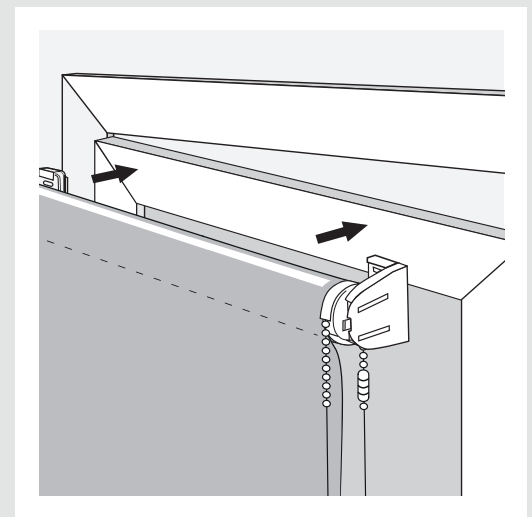

Day & Night Roller Blinds

- Harmony have 3 styles of Day & Night blinds to choose from.
- All Day & Night blinds use a beaded control chain.
- All Day & Night blinds can be top, face or side fitted.
- All window sizes are catered for; we fit any window in any country.
- Custom colours and sizes can be made to your specification.
- All Day & Night blinds are ready to hang or trim to size.
- All Day & Night blinds are packed in a clear PVC box offering clean, attractive, durable presentation at retail level.
- All product packaging includes a full colour header card and fitting instructions.

Packaging:

PVC box
PET box
Cardboard box
Mail order box

Container Quantities:

| | |
|-------------------|-----------|
| 20FT CONTAINER | 7,000pcs |
| 40FT CONTAINER | 14,000pcs |
| 40FT HC CONTAINER | 16,500pcs |

Scale of sizes:

| | | |
|-------------|-------------|-------------|
| 60 x 160cm | 60 x 175cm | 60 x 230cm |
| 90 x 160cm | 80 x 175cm | 80 x 230cm |
| 120 x 160cm | 100 x 175cm | 100 x 230cm |
| 150 x 160cm | 110 x 175cm | 110 x 230cm |
| 180 x 160cm | 120 x 175cm | 120 x 230cm |
| 210 x 160cm | 140 x 175cm | 140 x 230cm |
| 240 x 160cm | 160 x 175cm | 160 x 230cm |
| | 180 x 175cm | 180 x 230cm |
| | 90 x 210cm | 90 x 230cm |

Sizes Available:

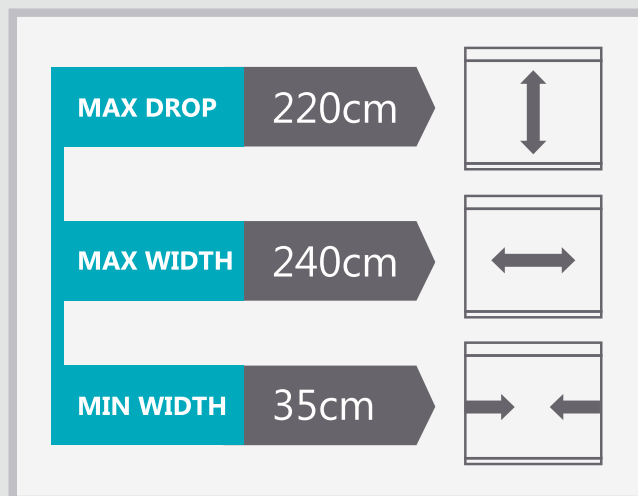

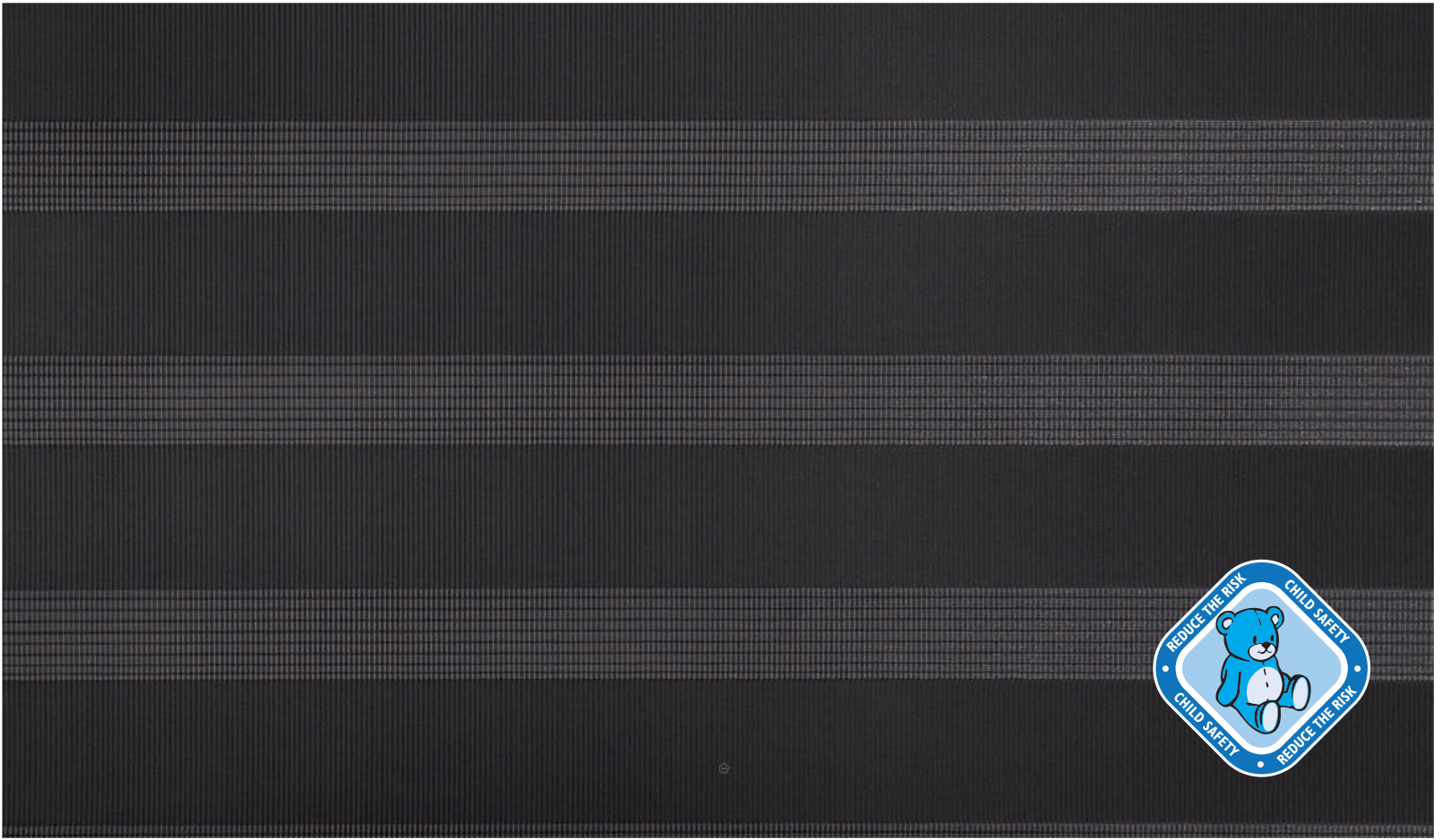

'L' Shape

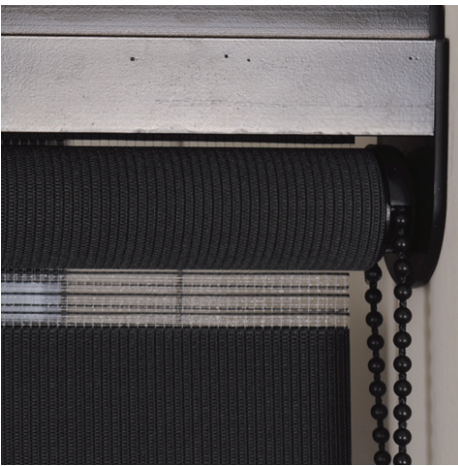

Cassette



Easy-Fix

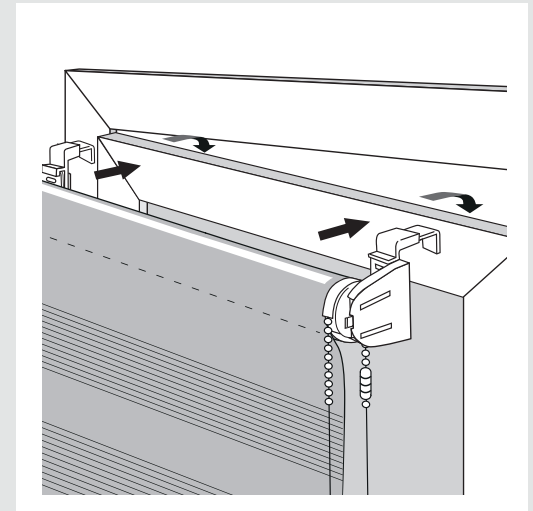

Roman Blinds

- Harmony have many styles / designs of Roman blinds to choose from.
- Harmony offer a Venetian or Spanish head rail system for all Roman blinds.
- All Roman blind fittings can be top or face fitted.
- All window sizes are catered for; we fit any window in any country.
- Custom colours and sizes can be made to your specification.
- All Roman blinds are ready to hang. Roman blinds cannot be cut down to size.
- All Roman blinds are packed in a clear PET box offering clean, attractive, durable presentation at retail level.
- Packaging size: 140mm x 40mm
- All product packaging includes a full colour header card and fitting instructions.

Fabrics Available

100% Polyester
Polycotton
Blackout
Dimout
Linen
Flock
Printed cotton panama

Head Rails:

25mm aluminum Venetian head rail
Spanish head rail

Packaging:

PVC box
PET box
Cardboard box
Mail order box

Scale of sizes:

| | |
|-------------|-------------|
| 45 x 170cm | 60 x 175cm |
| 60 x 170cm | 80 x 175cm |
| 75 x 170cm | 100 x 175cm |
| 90 x 170cm | 110 x 175cm |
| 105 x 170cm | 120 x 175cm |
| 120 x 170cm | 140 x 175cm |
| 135 x 170cm | 160 x 175cm |
| 150 x 170cm | 180 x 175cm |
| 180 x 170cm | 90 x 215cm |

Container Quantities:

| | |
|-------------------|-----------|
| 20FT CONTAINER | 7,000pcs |
| 40FT CONTAINER | 14,000pcs |
| 40FT HC CONTAINER | 16,500pcs |



'L' Shape

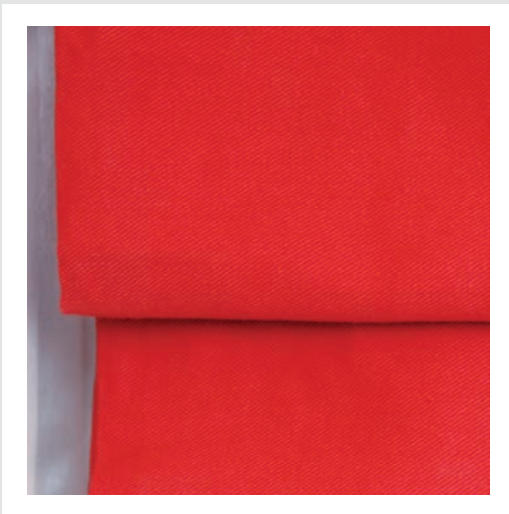

Cassette



Saver



Trim to Size Roman Blinds

Roman blinds are a very attractive window decoration, however they are notoriously difficult to 'trim & fit'.



Features & Benefits:

- High quality aluminium head rail is simple to use and provides a strong fixing of fabric to wall.
- Self-locking mechanism within the head rail & enables the blind to be opened, closed and held at the desired height easily.
- Snap fit brackets enable blind to be fitted inside or outside the window recess.
- Roller blind fabric used to provide great 'range' options for retail & wholesale, complimenting existing collections and styles.
- Clean finish to fabric edges enables easy trimming of the blind.
- Unique fittings provide 'trim & fit' flexibility.
- PVC bottom bar can be easily cut to size whilst keeping fabric taught.
- PET box packaging for clean durable presentation.

**PATENT
PENDING**

Harmony has developed a new exciting product which offers the flexibility of a roller blind and the functionality of a Roman blind. Our new product is extremely easy to 'trim and fit' should the readymade size not be an exact match for the consumer's window size.

This product is the perfect complement to any existing range of readymade blinds as we simply use the same fabric we use for roller blinds allowing the customer to mix and match designs and styles for any window setting.

This blind does not have any stitched hems, meaning trimming the blind is as easy as trimming a roller blind. You simply measure the width of the blind and cut the head rail and fabric to the desired measurement.



Vertical Blinds

- Harmony have many styles / designs of fabric to choose from.
- All plain dyed vertical fabrics are made from 100% polyester.
- All vertical blinds can be top and face fitting.
- All window sizes are catered for; we fit any window in any country.
- Vertical blinds requiring custom colours and sizes can be made to your specification.
- All vertical blinds are ready to hang or trim to size.
- All vertical blinds are packed in a clear PET box offering clean, attractive, durable presentation at retail level.
- Packaging size: 140mm x 40mm
- All product packaging includes a full colour header card and fitting instructions.

Fabrics Available

100% Polyester
Polycotton
Blackout
Linen
PVC

Headrails

Aluminium
PVC

Packaging:

PVC box
PET box
Cardboard box
Mail order box

Container Quantities:

20FT CONTAINER 7,000pcs
40FT CONTAINER 14,000pcs
40FT HC CONTAINER 16,500pcs

Sizes Available:

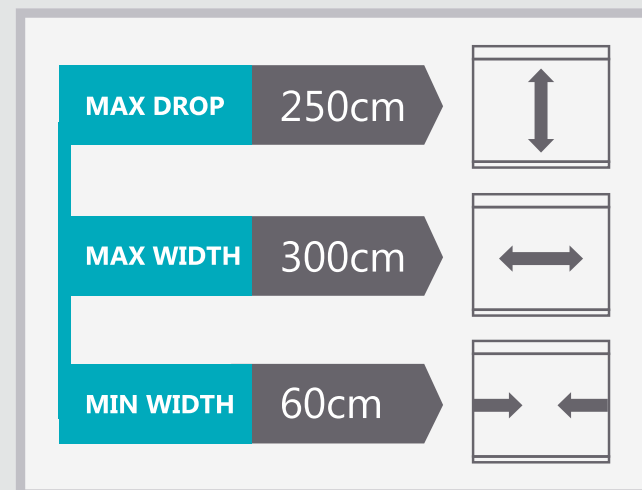

Scale of sizes:

| | | |
|-------------|-------------|-------------|
| 60 x 140cm | 60 x 240cm | 100 x 250cm |
| 90 x 140cm | 90 x 240cm | 110 x 250cm |
| 120 x 140cm | 120 x 240cm | 120 x 250cm |
| 150 x 140cm | 150 x 240cm | 140 x 250cm |
| 180 x 140cm | 180 x 240cm | 160 x 250cm |
| 210 x 140cm | 210 x 240cm | 180 x 250cm |
| 240 x 140cm | 240 x 240cm | 200 x 250cm |
| 300 x 140cm | 300 x 240cm | 250 x 250cm |
| | | 300 x 250cm |

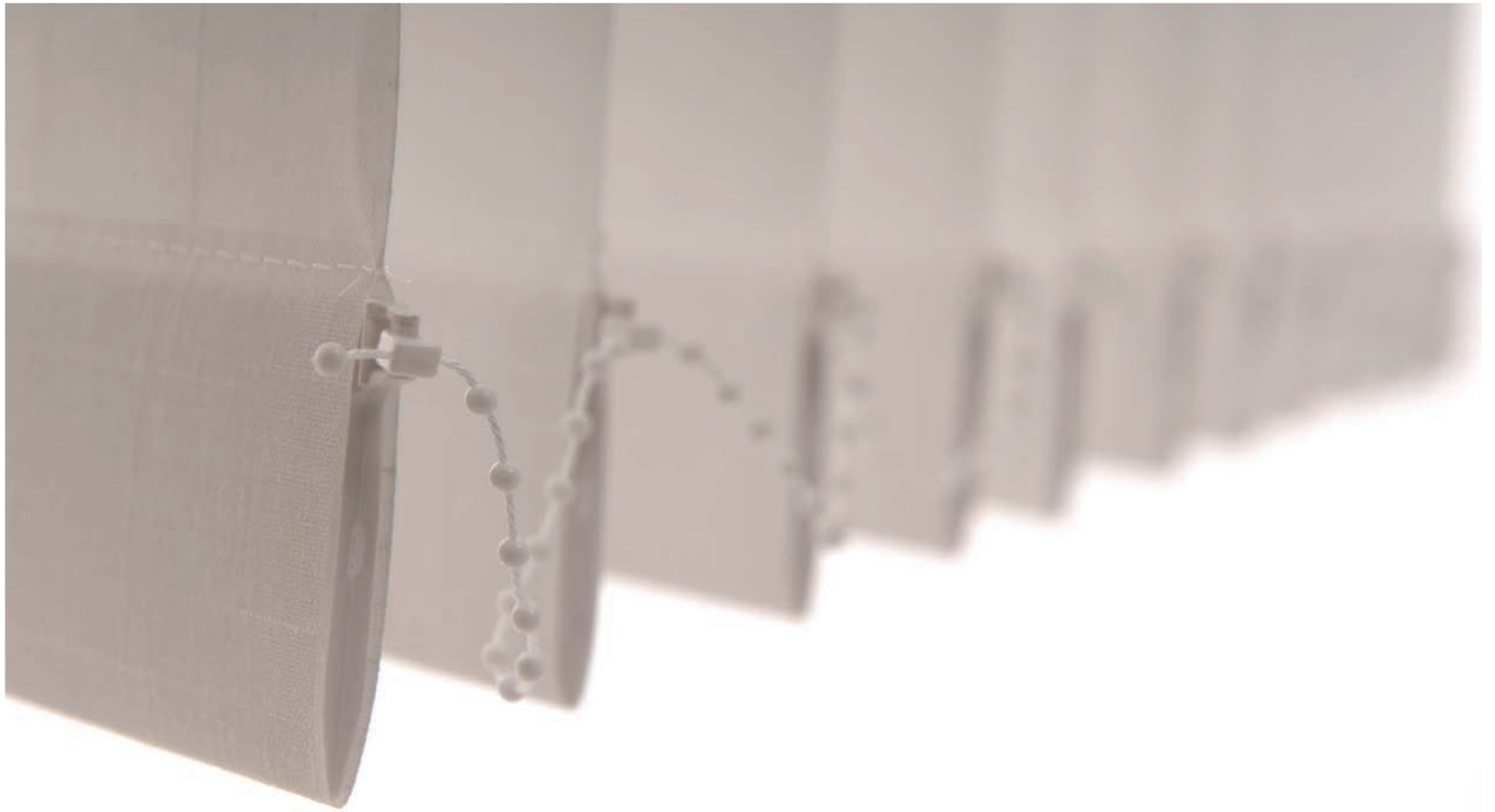

Daylight

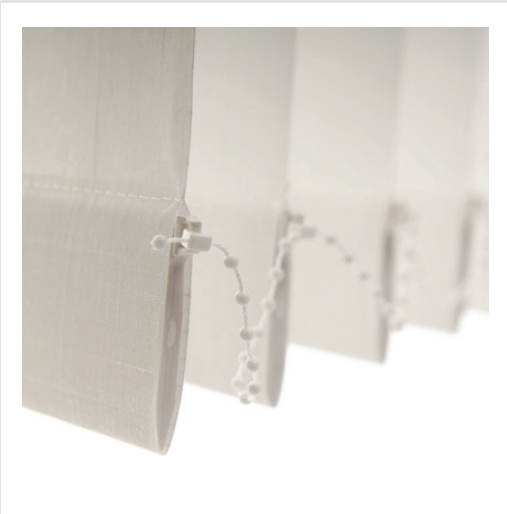

Blackout



Printed



Pleated Blinds

Pleated Blinds are a simple and effective form of window decoration. Harmony offer two pleated functions: Top down and top down, bottom up.

Fabric Types

100% Polyester 150 x 150 Denier
Non-woven fabric

Head Rail:

Aluminium

Packaging:

PVC box
PET box
Cardboard box
Mail order box

Scale of sizes:

EUROPE

| | | |
|-------------|-------------|-------------|
| 35 x 160cm | 60 x 175cm | 60 x 230cm |
| 60 x 160cm | 80 x 175cm | 80 x 230cm |
| 90 x 160cm | 100 x 175cm | 100 x 230cm |
| 120 x 160cm | 110 x 175cm | 110 x 230cm |
| 150 x 160cm | 120 x 175cm | 120 x 230cm |
| 180 x 160cm | 140 x 175cm | 140 x 230cm |
| 210 x 160cm | 160 x 175cm | 160 x 230cm |
| 240 x 160cm | 180 x 175cm | 180 x 230cm |
| | 90 x 210cm | 90 x 230cm |

Sizes Available:

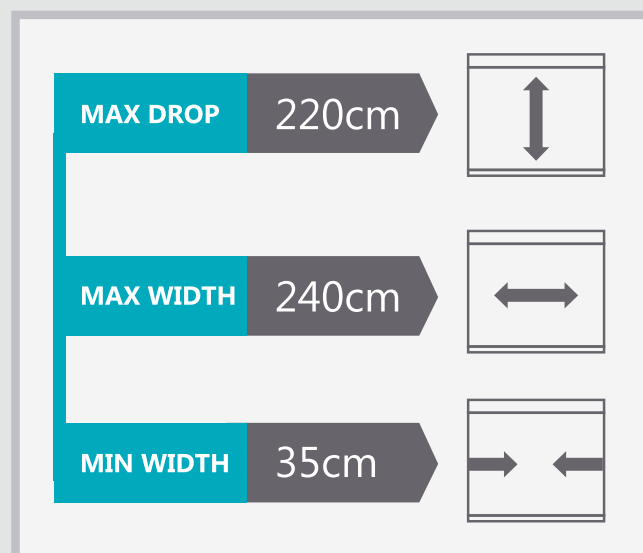



Panel Blinds

Japanses Style panel blinds bring a stylish look to any modern home setting. Available in wide range of fabrics, including printed, textured, sheer and blackout materials. Often displayed in a window setting with a mix of plain and printed fabrics look just fantastic.

These blinds are also often used as room dividers.

Fabric Types

100% Polyester 150 x 150 Denier

Head Rail:

Aluminium

Packaging:

PVC box
PET box
Cardboard box
Mail order box

Scale of sizes:

EUROPE

| | | |
|-------------|-------------|-------------|
| 35 x 160cm | 60 x 175cm | 60 x 230cm |
| 60 x 160cm | 80 x 175cm | 80 x 230cm |
| 90 x 160cm | 100 x 175cm | 100 x 230cm |
| 120 x 160cm | 110 x 175cm | 110 x 230cm |
| 150 x 160cm | 120 x 175cm | 120 x 230cm |
| 180 x 160cm | 140 x 175cm | 140 x 230cm |
| 210 x 160cm | 160 x 175cm | 160 x 230cm |
| 240 x 160cm | 180 x 175cm | 180 x 230cm |
| | 90 x 210cm | 90 x 230cm |

Sizes Available:

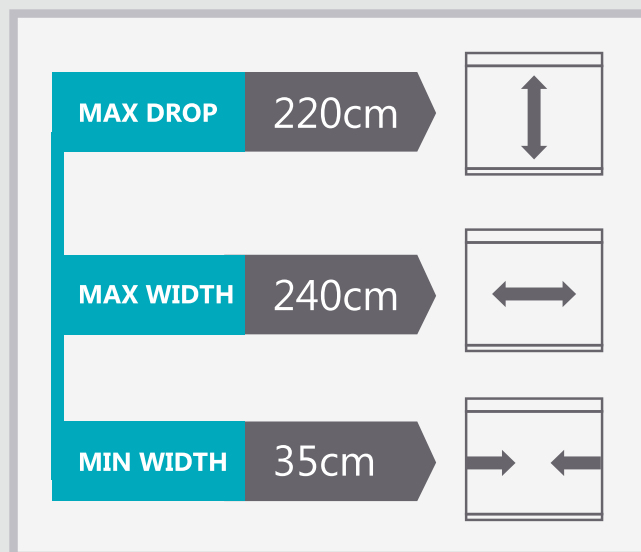

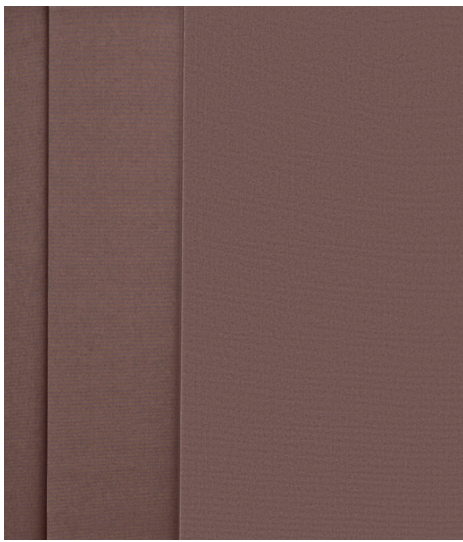

Roller Blind Accessories

Harmony provides the complete service for a comprehensive range of window decoration products. From the smallest to the largest customer, Harmony offer their market knowledge and product experience to provide unparalleled service and support from China and Europe.

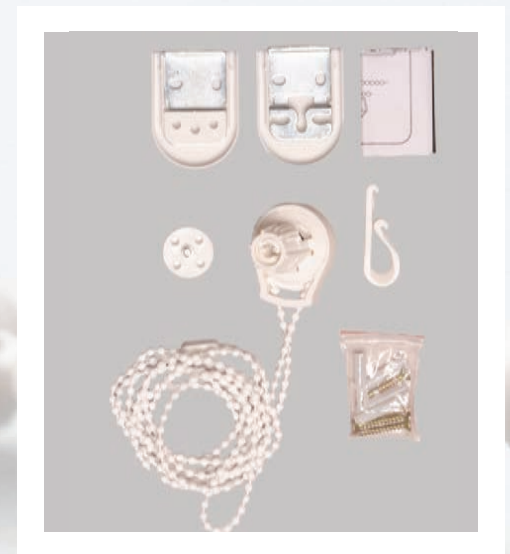
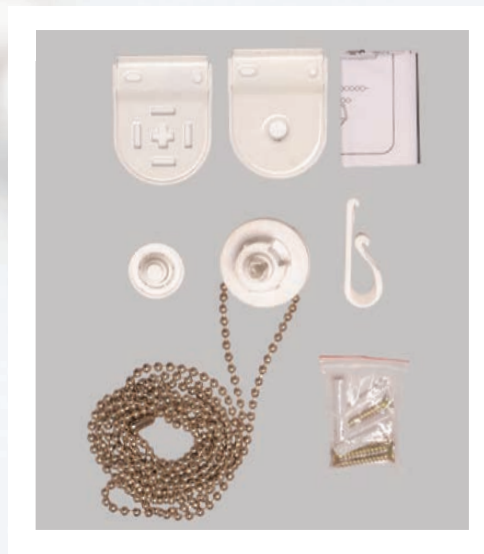
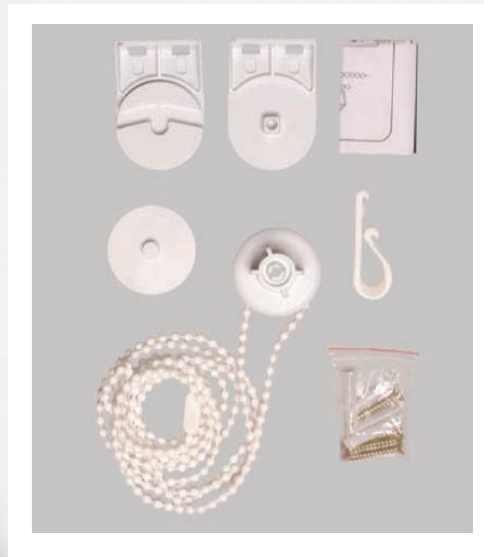



Harmony Factory Photos



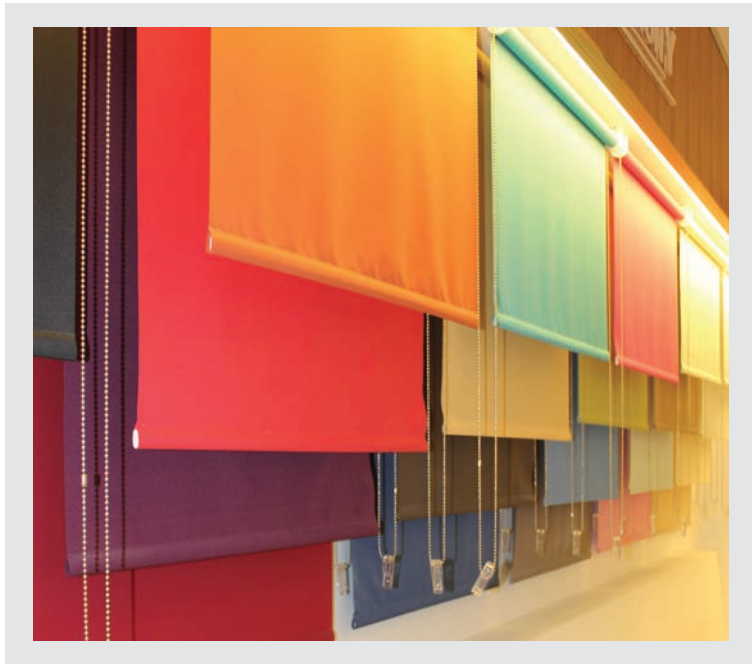

Harmony Factory Photos Continued

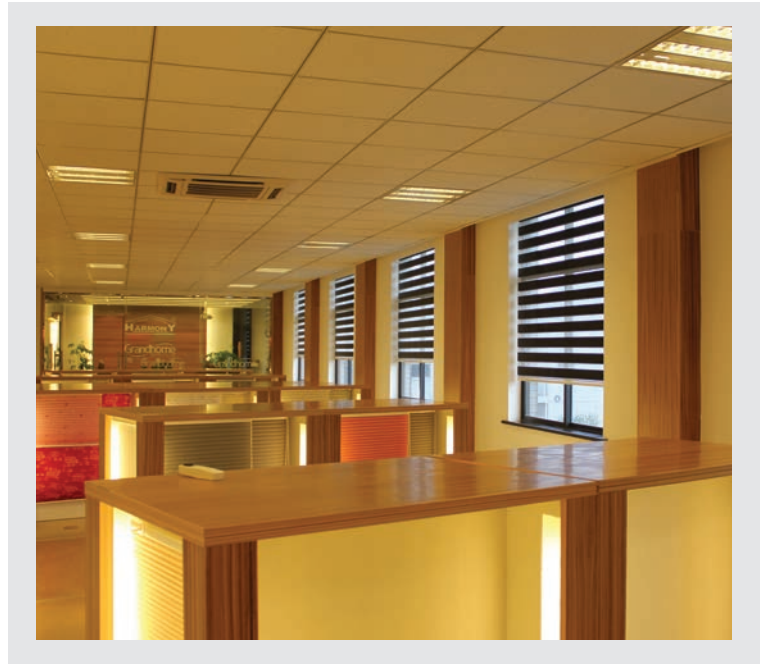



Contact us

The Harmony Group of Companies:

- Grand Home Furnishing Company Limited
- Ningbo Gileko Commodity Company Limited
- Harmony Home Furnishings Limited
- P & H International Limited
- Aly Décor Products Co. Limited



Global Sales Office

Harmony / Aly Décor
Unit 7 Saddlers Court
Oakham Office Park
Oakham, Rutland.
United Kingdom
LE15 7GH

Contact

Name: Jeremy Dawson
Position: Global Sales Director
Tel: +44 (0) 844 756 1756
Mob: +44 (0) 7876 202024
Email: jeremy@cnharmony.co.uk
Email: sales@cnharmony.com
Web: www.cnharmony.com

Blinds Factory Address

Harmony
365 North Keyuan Road
Ninghai, Ningbo,
Zhejiang,
China PRC
315609

Metal Pole Factory Address

Aly Décor
No. 23,
Ruhu West Road,
Simen Town, Yuyao City,
Zhejiang,
China PRC
315470





HARMONY[®]

Grandhome
FURNISHING

Find out more at www.cnharmony.com